



IJB Series

INDUCED JET FAN



Introduction

Fan

Construction

Double flanged casing is produced in mild steel or galvanized steel. Impeller is made of Aluminum.

Finish

Zinc rich primer and polyester powder coating or galvanized finishing are available for all mild steel parts.

Motors

Totally enclosed Class 'F' / 'H' motors with a min. IP54 protection are fitted as standard. Motors up to 2.2kW are supplied with DOL starting, motors 3.0kW and above are with star/delta starting.

Flow Direction

Uni-directional, reversible fan is available upon request.

Silencer

- Outer casing made of galvanized steel sheet and inner casing made of galvanized steel perforated sheet.
- Inlet bell-mouth provided for smooth airflow.
- Glass fiber as absorption filler material to achieve excellent acoustic performance.
- Each model is available with 2D silencer as standard. Non-standard length to meet special performance requirement can be supplied upon request.

Dimension

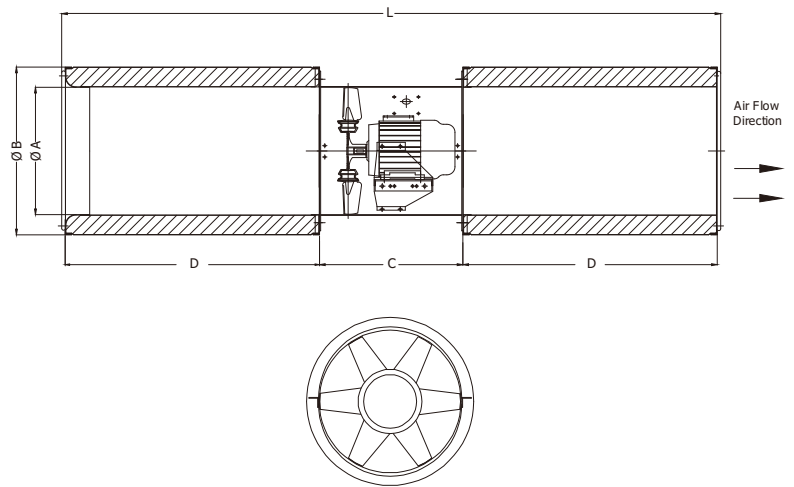

Model	A	B	C (Max)	D	L (2D, Max)
IJB 315	315	415	355	630	1635
IJB 355	355	455	400	710	1840
IJB 400	400	500	450	800	2060
IJB 450	450	550	500	900	2310

All dimension in mm.

Certificate



Kruger Ventilation Industries Asia Co.,Ltd certifies that the **IJB series** model 315 to 450 shown herein is licensed to bear the AMCA Seal. The ratings shown are based on tests and procedures performed in accordance with AMCA Publication 211 and AMCA Publication 311 and comply with the requirements of the AMCA Certified Ratings Program.



Certified by **TÜV SÜD** which is a leading international service organization focusing on consulting, testing, certification and training.



IJB series was tested in accordance with EN 12101- 3:2015.

Class	Temperature (°C)	Minimum functioning period (minutes)
F _r 250	250	120
F _r 300	300	60
F _r 300	300	120
F _r 400	400	120

Technical Data

Model	Maximum Flow Rate (m ³ /h)	Outlet Velocity (m/s)	Thrust Force (N)	Absorbed Power at free discharge (kW)	Installed Power (kW)		Speed (RPM)	Hz	Voltage (V)	Phase	Lw(A) at free discharge dB(A)*	Lp(A) at 3m free discharge dB(A)**
					Single Speed	Two Speed						
IJB 315	4619	16	25	0.49	0.55	0.75/0.15	2850	50	400	3	90	69
	2350	8	7	0.06	0.37		1450				73	52
IJB 355	7181	20	48	1.11	1.50	1.5/0.3	2850	50	400	3	89	68
	3653	10	12	0.15	0.37		1450				70	50
IJB 400	9443	21	66	1.72	2.20	2.2/0.44	2850	50	400	3	90	70
	4804	11	17	0.23	0.37		1450				71	51
IJB 450	13438	23	105	2.48	3.00	3.6/0.72	2850	50	400	3	92	71
	6837	12	27	0.33	0.55		1450				72	52

* Values shown are for inlet Lwi(A) sound power levels for installation type A: free inlet, free outlet. The A-weighted sound ratings shown have been calculated per AMCA International Standard 301.

** Inlet Lp(A) sound pressure levels at 3m are measured at free discharge in spherical free field condition, inlet Lp(A) (dB(A)) levels are not licensed by AMCA International.

- Power ratings shown are for Kruger motors.

- Performance ratings include the effects of appurtenances (2D inlet silencer and 2D outlet silencer).

- Performance certified is for installation type A - Free inlet, Free outlet.

Velocity Profile

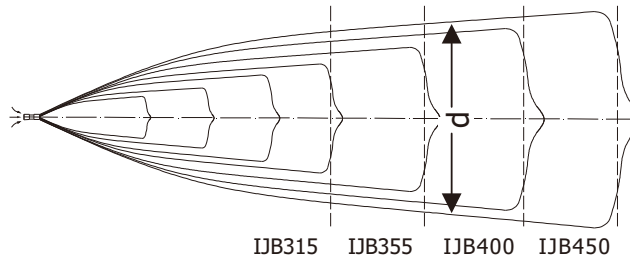

Note: H - High Speed
L - Low Speed

Distance from Nozzle (m)		2	4	6	8	10	12	14	16	18	20	22	24
Flow width d (m)		0.85	1.70	2.55	3.40	4.25	5.10	5.95	6.80	7.65	8.50	9.35	10.20
Center Line Velocity (m/s)*	IJB 315 H	11.29	6.97	4.86	3.74	3.03	2.55	2.19	1.83	1.47	1.10	1.05	1.00
	IJB 315 L	5.79	3.59	2.49	1.92	1.54	1.31	1.13	0.94	0.75	0.56	0.54	0.51
	IJB 355 H	13.44	9.11	6.39	4.92	4.00	3.37	2.91	2.55	2.28	2.01	1.74	1.47
	IJB 355 L	6.58	4.48	3.15	2.41	1.97	1.64	1.43	1.26	1.12	0.99	0.85	0.72
	IJB 400 H	14.58	10.35	7.32	5.65	4.58	3.88	3.34	2.95	2.64	2.38	2.16	1.99
	IJB 400 L	7.57	5.39	3.84	2.97	2.39	2.04	1.74	1.54	1.39	1.24	1.14	1.03
	IJB 450 H	15.43	11.29	8.62	6.63	5.41	4.58	3.95	3.49	3.12	2.82	2.57	2.37
	IJB 450 L	8.11	5.85	4.48	3.46	2.83	2.38	2.07	1.81	1.63	1.48	1.34	1.24

Distance from Nozzle (m)		26	28	30	32	34	36	38	40	42	44	46	48
Flow width d (m)		11.05	11.90	12.75	13.60	14.45	15.30	16.15	17.00	17.85	18.70	19.56	20.41
Center Line Velocity (m/s)*	IJB 315 H	0.95	0.90	0.85	0.81	0.77	0.73	0.70	0.66	0.63	-	-	-
	IJB 315 L	-	-	-	-	-	-	-	-	-	-	-	-
	IJB 355 H	1.39	1.32	1.26	1.19	1.13	1.08	1.02	0.97	0.92	0.88	0.83	0.79
	IJB 355 L	0.69	0.65	0.62	-	-	-	-	-	-	-	-	-
	IJB 400 H	1.85	1.65	1.46	1.38	1.31	1.25	1.19	1.07	1.02	0.97	0.93	0.89
	IJB 400 L	0.96	0.87	0.76	0.72	0.69	0.65	0.62	-	-	-	-	-
	IJB 450 H	2.19	2.03	1.91	1.80	1.68	1.60	1.52	1.44	1.37	1.30	1.24	1.18
	IJB 450 L	1.13	1.05	1.00	0.93	0.87	0.83	0.79	0.75	0.72	0.68	0.65	0.61

* Tentative data based on free air jet

Fan Performance Curve - 50 Hz

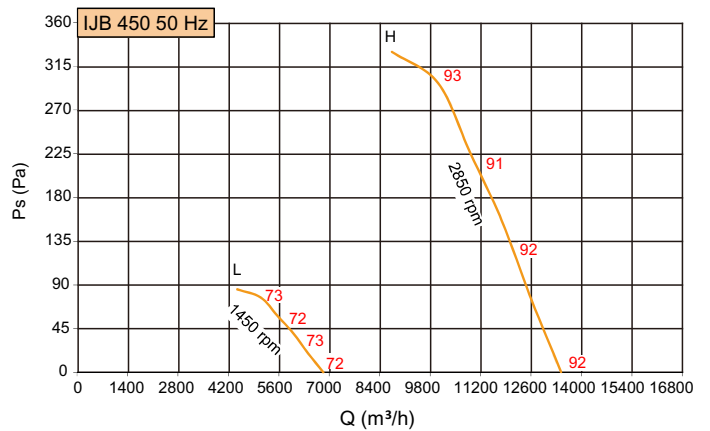
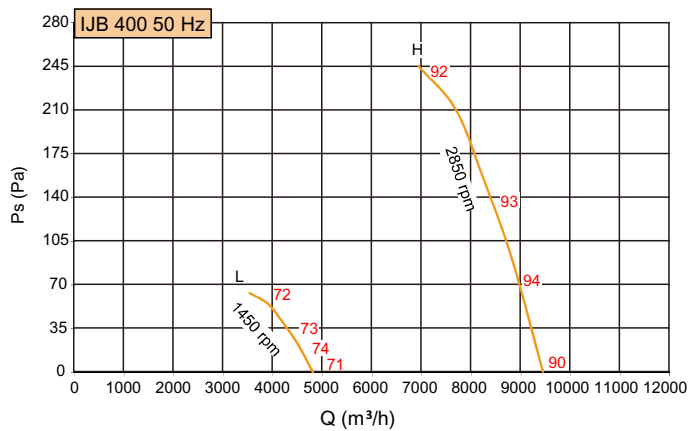
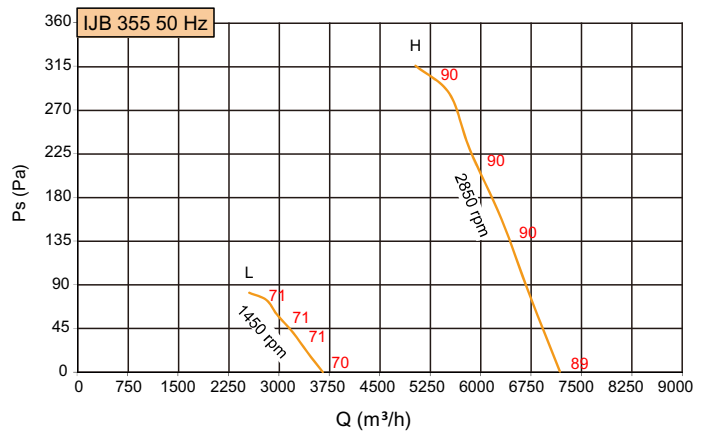
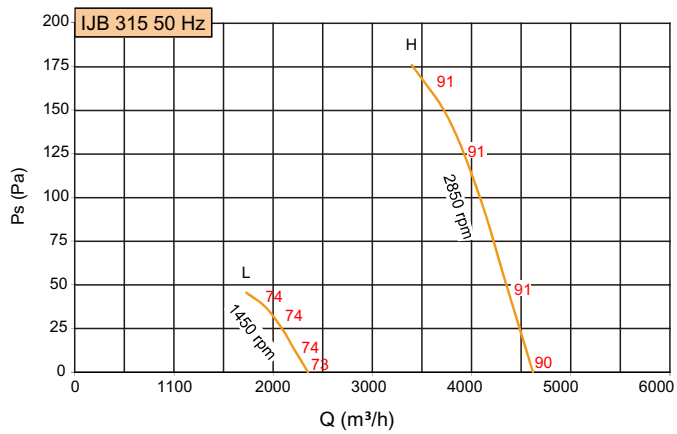

- Values shown are for inlet Lwi(A) sound power levels for installation type A: free inlet, free outlet. The A-weighted sound ratings shown have been calculated per AMCA International Standard 301.
- Performance certified is for installation type A – Free inlet, Free outlet.
- Performance ratings include the effects of appurtenances (2D inlet silencer and 2D outlet silencer).

Accessories

Mounting Feet

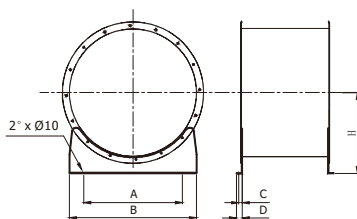

Hanger

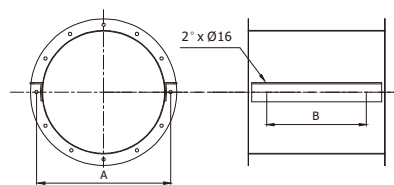

Dimension

Model	Mounting Feet				Hanger				
	A	B	C	D	H	Wt/set(kg)	A	B	Wt/set(kg)
IJB 315	265	315	25	50	264	2.0	355	263	2.2
IJB 355	290	355	25	50	260	2.0	395	263	2.2
IJB 400	304	400	25	50	265	2.5	440	338	2.2
IJB 450	375	450	25	50	288	3.0	490	338	2.4

All dimension in mm.

KRUGER GROUP (VENTILATION)

· THAILAND (Regional HQ)

KRUGER VENTILATION INDUSTRIES ASIA CO. LTD.

30/159 Moo 1, Sinsakorn Industrial Estate,
Chetsadawithi Road, Khok Kham Mueng, Samuthsakorn 74000, Thailand
Tel. +662 1054298 - Fax +662 0248256-9
Website: www.krugerfan.com

• CHINA (BEIJING)

BEIJING KRUGER VENTILATION CO. LTD

Level 7, A Block, Rising International Building, 29 JingHai San Road, BDA,
Beijing, P.R.China 100176
Tel. +86 10-67881366 - Fax +86 10-67880566
Email: krugertj@krugertj.com

• CHINA (SHANGHAI)

SHANGHAI KRUGER VENTILATION CO. LTD

No. 500 Yuanguo Road, Anting, Jiading,
Shanghai 201814 P.R. China
Tel. +86 21-69573266 - Fax +86 21-69573296
Email: shkruger@krugerchina.com

· CHINA (WUHAN)

WUHAN KRUGER VENTILATION CO. LTD

No. 805, Huian Ave, Dongxihu District, Wuhan, Hubei, P.R. China 430000
Tel. +86 27- 83248840/83060522/83097505
Fax +86 27- 83261886
Email: whkruger@krugerwh.com

· HONG KONG

KRUGER VENTILATION (HONG KONG) LIMITED

Flat C, 9/F, Yeung Yiu Chung (No.8) Industrial Building,
20 Wang Hoi Road, Kowloon Bay, Kowloon, Hong Kong
Tel. +852 22469182 - Fax +852 22469187
Email: info@kruger.com.hk

· INDIA (NORTH)

KRUGER VENTILATION INDUSTRIES (NORTH INDIA) PVT LTD

Plot No. - 191, Sector - 59, Ballabgarh, Faridabad - 121 004, Haryana, India
Tel. +91-9958991660/9717449696
Fax. +91-1294135820
Email: sales.kni@krugerindia.com

· KOREA

NEOMATE CO. LTD

2-1010, Ace High Tech City B/D, 775 Gyeongin-ro,
Yeongdeungpo-gu, Seoul, Korea. Postal Code 07299
Tel. +82-2-2679-2052 - Fax. +82-2-2679-2174
Email: y7890@neomate.co.kr

· MYANMAR

KRUGER VENTILATION (MYANMAR) CO.LTD

Room No. F21, Thiri Yadanan Whole Sale Market, (Htawunbe)
Toe Chae Ward, North Okkalapa Township, Yangon.
Tel. +959 763141081/2/3
Email: htoon@krugermm.com

· SINGAPORE

KRUGER ENGINEERING PTE LTD

No. 10 Buroh Street #06-06, West Connect Building,
Singapore 627564
Tel. +65 68631191 - Fax +65 68631151
Email: mktg@krugerasia.com

· THAILAND

KRUGER VENTILATION IND. (THAILAND) CO. LTD

30/105 Moo 1, Sinsakorn Industrial Estate,
Chetsadawithi Road, Khok Kham Mueng, Samuthsakorn 74000, Thailand
Tel. +662 1050399 - Fax + 662 1050370-2
Email: mktg@kruger.co.th

· AUSTRALIA

S&P-KRUGER AUSTRALIA PTY LTD

2 Cunningham St, Moorebank N.S.W. 2170
Tel. +61 2-98227747
Fax. +61 2-98227757
Email: info@sandpkruger.com.au

· CHINA (GUANGZHOU)

GUANGZHOU KRUGER VENTILATION CO. LTD

No. 9 Huahui Road, Huashan, Huadu,
Guangzhou, P.R. China 510880
Tel. +86 20-66356635 - Fax +86 20-86786001/86786500
Email: gzkru@krugergz.com

· CHINA (TIANJIN)

TIANJIN KRUGER VENTILATION CO. LTD

No.168 Anyuan Road, Jingjin Science and Technology Park
Wuqing District, Tianjin, China
Tel. +86 22-22143480/3481 - Fax +86 22-22143482
Email: krugertj@krugertj.com

· DUBAI

KRUGER VENTILATION INDUSTRIES, GULF BRANCH

Jebel Ali Free Zone Area (JAFZA) P.O. Box No. 262949, Dubai, UAE
Tel. +971 4 8819188/8832017
Fax. +971 4 8832018
Email: johncs@krugerasia.com

· INDIA

KRUGER VENTILATION INDUSTRIES (INDIA) PVT LTD

Kruger Centre, Mumbai-Nasik Highway,
Kalamgaon, Shahapur, Thane 421601, Maharashtra, India
Tel. +91 9960558899/9975577211 - Fax +91 2527 240075
Email: sales@krugerindia.com

· INDONESIA

P.T. KRUGER VENTILATION INDONESIA

JL. Teuku Umar No.20,
Karawaci - Tangerang 15115, Indonesia
Tel. +62 21-5512288/5513557 - Fax +62 21-5513502
Email: mktg@krugerindo.co.id

· MALAYSIA

KRUVENT INDUSTRIES (M) SDN BHD

Lot 850, Jalan Subang 7, Taman Perindustrian Subang,
47500, Subang Jaya, Selangor D.E.
Tel. +603 80743399 - Fax +603 80743388
Email: mktg@kruger.com.my

· PHILIPPINES

KRUGER M&E INDUSTRIES CORPORATION

FAPI Compound, E. Rodriguez Ave.
Tunasan, Muntinlupa City 1773, Philippines
Tel. +63 2-8622892/4/6/7, 5534059 - Fax +63 2-8622891
Email: mktg@krugerph.net

· TAIPEI

KRUGER VENTILATION (TAIWAN) CO. LTD

No. 157, Ping-an Rd, Hengfeng Village,
Dayuan Shiang Taoyuan County 337, Taiwan
Tel. +886 3-3859119 - Fax +886 3-3859118
Email: sales@krugertwn.com.tw

· VIETNAM

KRUGER VENTILATION INDUSTRIES (VIETNAM) CO. LTD

Lot A7. 2-4, C2 Road, Thanh Thanh Cong IZ,
Trang Bang Dist. Tay Ninh Province, Vietnam
Tel. +84-276 3585200/01/02 - Fax +84-276 3585199
Email: mktg@krugervn.com

The company is always improving and developing its products, therefore the company reserves the right of making changes to the illustrated products. Certified dimension can be provided upon request.